

CliQ II DIN Rail Power Supply

24 V 960 W 3 Phase / DRP024V960W3BN



Highlights & Features

- Universal AC input voltage range
- Power will not de-rate for the entire input voltage range
- Power Boost of 150% for 5 seconds
- Full corrosion resistant aluminium casing
- Conforms to harmonic current IEC/EN 61000-3-2, Class A
- Extreme low temperature cold start at -40°C
- Conformal coating on PCBAs to protect against common dust and chemical pollutants
- Certified according to IEC/EN/UL 62368-1

Safety Standards



CB Certified for worldwide use

Model Number: DRP024V960W3BN
Unit Weight: 2.60 kg (5.73 lb)
Dimensions (L x W x D): 121 x 255 x 117.3 mm
 (4.76 x 10.0 x 4.62 inch)

General Description

The CliQ II 3-phase DIN rail power supply series offers output voltage of 24 V. These products are encased in rugged yet lightweight full aluminium body that can withstand shock and vibration according to IEC 60068-2 standard. The DRP024V960W3BN operates over a temperature range of -25°C to +65°C and wide input range for 3-phase from 320 Vac to 600 Vac or 2-phase from 380 Vac to 600 Vac, with no power de-rating throughout the entire range. Like the rest of the models in the CliQ series, conformal coating is applied on the PCBAs to protect against common dust and chemical pollutants. The design conforms to harmonic current emission IEC/EN 61000-3-2 standard.

Model Information

CliQ II DIN Rail Power Supply

Model Number	Input Voltage Range	Rated Output Voltage	Rated Output Current
DRP024V960W3BN	3 x 320-600 Vac (3-Phase) or 2 x 380-600 Vac (2-Phase)	24 Vdc	40.0 A

Model Numbering

DR	P	024V	960W	3	B	N
DIN Rail	Power Supply	Output Voltage	Output Power	Three Phase	CliQ II Series	N - Metal Case, without Class I, Div 2

CliQ II DIN Rail Power Supply

24 V 960 W 3 Phase / DRP024V960W3BN

Specifications

Input Ratings / Characteristics

Nominal Input Voltage	3 x 400-500 Vac
Input Voltage Range ¹⁾	3 x 320-600 Vac (3-Phase) or 2 x 380-600 Vac (2-Phase)
Nominal Input Frequency	50-60 Hz
Input Frequency Range	47-63 Hz
Nominal DC Input Voltage	500 Vdc
DC Input Voltage Range ²⁾	450-800 Vdc
Input Current	< 1.70 A @ 3 x 400 Vac, < 1.40A @ 3 x 500 Vac
Efficiency at 100% Load	> 92.0% @ 3 x 400 Vac & 3 x 500 Vac
Max Power Dissipation	0% load < 5.8 W @ 3 x 400 Vac, < 6.2 W @ 3 x 500 Vac
	100% load < 83.4 W @ 3 x 400 Vac & 3 x 500 Vac
Max Inrush Current (Cold Start)	< 60 A @ 3 x 400 Vac & 3 x 500 Vac
Power Factor at 100% Load	> 0.95 @ 3 x 400 Vac, > 0.94 @ 3 x 500 Vac
Leakage Current	< 3.5 mA @ 3 x 600 Vac

1) Safety approval for up to 600 Vac maximum.

2) Safety approval according to IEC/EN/UL 60950-1 and IEC/EN/UL 62368-1.

Output Ratings / Characteristics³⁾

Nominal Output Voltage	24 Vdc
Factory Set Point Tolerance	24 Vdc \pm 2%
Output Voltage Adjustment Range	24-28 Vdc
Output Current	40.0 A (continuously operating at 24 V) 60.0 A (Power Boost for 5 seconds at 24 V, refer to the details in the Functions section)
Output Power	960 W (continuously operating at 24 V) 1,440 W (Power Boost for 5 seconds at 24 V, refer to the details in the Functions section)
Line Regulation	< 0.5% (@ 3 x 320-600 Vac input, 100% load)
Load Regulation	< 1.0% (@ 3 x 320-600 Vac input, 0-100% load)
PARD ⁴⁾ (20 MHz)	< 240 mVpp
Rise Time	< 100 ms @ nominal input (100% load)
Start-up Time	< 1,500 ms @ nominal input (100% load)
Hold-up Time	> 20 ms @ 3 x 400 Vac & 3 x 500 Vac (100% load)
Dynamic Response (Overshoot & Undershoot O/P Voltage)	\pm 5% @ 3 x 320-600 Vac input, 10-100% load (Slew Rate: 0.1 A/ μ s, 50% duty cycle @ 5 Hz to 1 KHz)
Start-up with Capacitive Loads	10,000 μ F Max

3) For power de-rating from 50°C to 65°C, see power de-rating on page 3.

4) PARD is measured with an AC coupling mode, 5 cm wires, and in parallel with 0.1 μ F ceramic capacitor & 47 μ F electrolytic capacitor.

CliQ II DIN Rail Power Supply

24 V 960 W 3 Phase / DRP024V960W3BN

Mechanical

Case Cover / Chassis	Aluminium	
Dimensions (L x W x D)	121 x 255 x 117.3 mm (4.76 x 10.0 x 4.62 inch)	
Unit Weight	2.60 kg (5.73 lb)	
Indicator	Green LED	DC OK
Cooling System	Convection	
Terminal	Input	4 Pins (Rated 600 V / 35 A)
	Output	6 Pins (Rated 300 V / 30 A)
Wire	Input	AWG 18-8
	Output	AWG 12-10 ¹⁾
Mounting Rail	Standard TS35 DIN Rail in accordance with EN 60715	
Noise (1 Meter from power supply)	Sound Pressure Level (SPL) < 40 dBA	

1) For AWG 12-10, ensure that all output terminals are connected.

Environment

Surrounding Air Temperature	Operating	-25°C to +65°C (Cold Start at -40°C)
	Storage	-40°C to +85°C
Power De-rating	Vertical Mounting	> 50°C de-rate power by 2.5% / °C
Operating Humidity	5 to 95% RH (Non-Condensing)	
Operating Altitude	0 to 2,500 Meters (8,200 ft.)	
Shock Test	Non-Operating	IEC 60068-2-27, 30 G (300 m/S ²) for a duration of 18 ms, 1 times per direction, 2 times in total
Vibration	Non-Operating	IEC 60068-2-6, 10 Hz to 500 Hz @ 30 m/S ² (3 G peak); 60 min per axis for all X, Y, Z direction
Bump Test	Operating	IEC 60068-2-29, Half Sine Wave: 10 G for a duration of 11 ms, 1,000 times per direction, 6,000 times in total
Over Voltage Category	III	According to IEC/EN 62477-1 / EN 60204-1 (clearance and creepage distances) and IEC 62103 (safety part)
Pollution Degree	2	

Protections

Overvoltage	< 32 V, ±10%, SELV Output, Hiccup Mode, Non-Latching (Auto-Recovery)
Overload / Overcurrent	> 150% of rated load current, Hiccup Mode, Non-Latching (Auto-Recovery)
Over Temperature	< 65°C Surrounding Air Temperature @ 100% load, Non-Latching (Auto-Recovery)
Short Circuit	Hiccup Mode, Non-Latching (Auto-Recovery when the fault is removed)
Transient Surge Voltage Protection	MOV (Metal Oxide Varistor)
Internal Fuse	T 4 A H
Degree of Protection	IP20
Protection Against Shock	Class I with PE ²⁾ connection

2) PE: Primary Earth

CliQ II DIN Rail Power Supply

24 V 960 W 3 Phase / DRP024V960W3BN

Reliability Data

MTBF	> 300,000 hrs. as per Telcordia SR-332 I/P: 3 x 400 Vac, O/P: 100% load, Ta: 25°C
Expected Cap Life Time	10 years (3 x 400 Vac & 3 x 500 Vac, 50% load @ 40°C)

Safety Standards / Directives

Electrical Equipment of Machines	EN/BS EN 60204-1 (over voltage category III)	
Electrical Equipment for Use in Electrical Power Installations	IEC/EN/BS EN 62477-1 / IEC 62103	
Safety Entry Low Voltage	SELV (IEC 60950-1)	
Electrical Safety	SIQ Bauart	EN 62368-1
	UL/cUL recognized	UL 60950-1 and CSA C22.2 No. 60950-1 (File No. E191395) UL 62368-1 and CSA C22.2 No. 62368-1 (File No. E191395)
	CB scheme	IEC 60950-1, IEC 62368-1
	UKCA	BS EN 62368-1
Industrial Control Equipment	UL/cUL listed	UL 508 and CSA C22.2 No. 107.1-01 (File No. E315355)
	CSA	CSA C22.2 No. 107.1-01 (File No. 181564)
BIS	IS 13152-1	
CE	In conformance with EMC Directive 2014/30/EU and Low Voltage Directive 2014/35/EU	
UKCA	In conformance with Electrical Equipment (Safety) Regulations 2016 No. 1011 and The Electromagnetic Compatibility Regulations 2016 No. 1091	
Galvanic Isolation	Input to Output	4.0 KVac
	Input to Ground	2.0 KVac
	Output to Ground	1.5 KVac

CliQ II DIN Rail Power Supply

24 V 960 W 3 Phase / DRP024V960W3BN

EMC

Emissions (CE & RE)		Generic Standards: CISPR 32, EN/BS EN 55032, CISPR 11, EN/BS EN 55011, FCC Title 47: Class B
Component Power Supply for General Use		EN/BS EN 61204-3
Immunity		Generic Standards: EN/BS EN 55024, EN/BS EN 61000-6-2
Electrostatic Discharge	IEC 61000-4-2	Level 4 Criteria A ¹⁾ Air Discharge: 15 kV Contact Discharge: 8 kV
Radiated Field	IEC 61000-4-3	Level 3 Criteria A ¹⁾ 80 MHz-1 GHz, 10V/M, 80% modulation (1 KHz) 1.4 GHz-2 GHz, 3V/M, 80% modulation (1 KHz) 2 GHz-2.7 GHz, 1V/M, 80% modulation (1 KHz)
Electrical Fast Transient / Burst	IEC 61000-4-4	Level 3 Criteria A ¹⁾ 2 kV
Surge	IEC 61000-4-5	Level 3 Criteria A ¹⁾ Common Mode ²⁾ : 2 kV Differential Mode ³⁾ : 1 kV
Conducted	IEC 61000-4-6	Level 3 Criteria A ¹⁾ 150 kHz-80 MHz, 10 Vrms
Power Frequency Magnetic Fields	IEC 61000-4-8	Criteria A ¹⁾ 30 A/Meter
Voltage Dips and Interruptions	IEC 61000-4-11	100% dip; 1 cycle (20 ms); Self Recoverable
Low Energy Pulse Test (Ring Wave)	IEC 61000-4-12	Level 3 Criteria A ¹⁾ Common Mode ²⁾ : 2 kV Differential Mode ³⁾ : 1 kV
Harmonic Current Emission		IEC/EN/BS EN 61000-3-2, Class A
Voltage Fluctuation and Flicker		IEC/EN/BS EN 61000-3-3

1) Criteria A: Normal performance within the specification limits

2) Asymmetrical: Common mode (Line to earth)

3) Symmetrical: Differential mode (Line to line)

CliQ II DIN Rail Power Supply

24 V 960 W 3 Phase / DRP024V960W3BN

Block Diagram

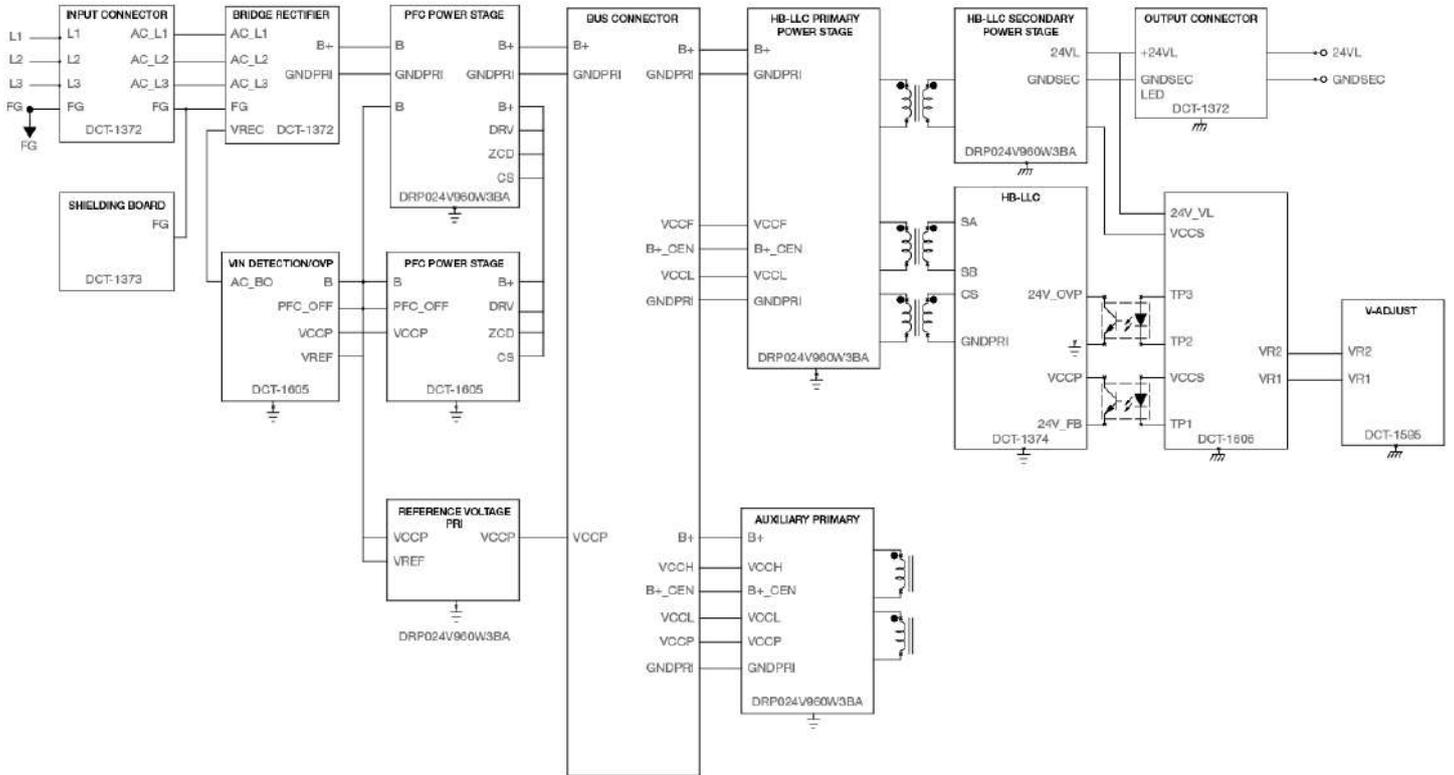

Device Description

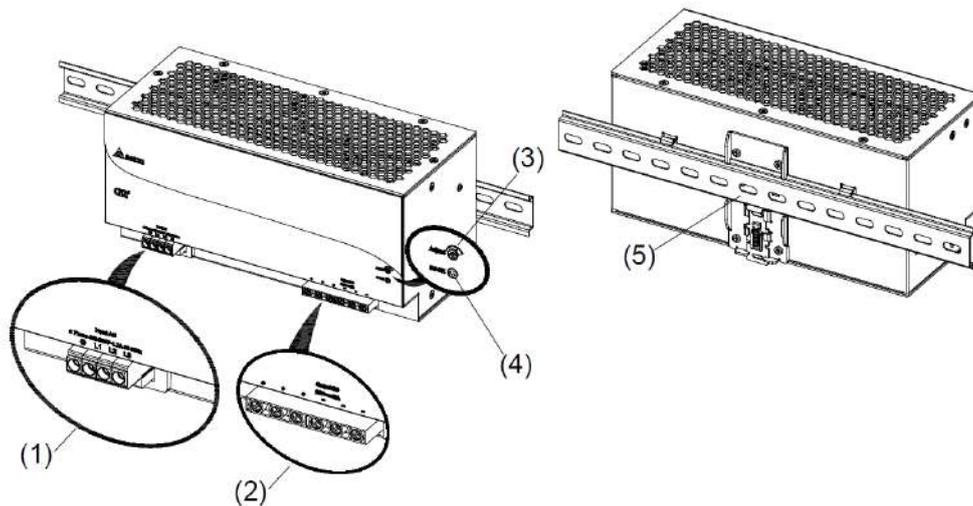

- 1) Input terminal block connector
- 2) Output terminal block connector
- 3) DC Voltage adjustment potentiometer
- 4) DC OK control LED (Green)
- 5) Universal mounting rail system

CliQ II DIN Rail Power Supply

24 V 960 W 3 Phase / DRP024V960W3BN

Dimensions

L x W x D: 121 x 255 x 117.3 mm (4.76 x 10.0 x 4.62 inch)

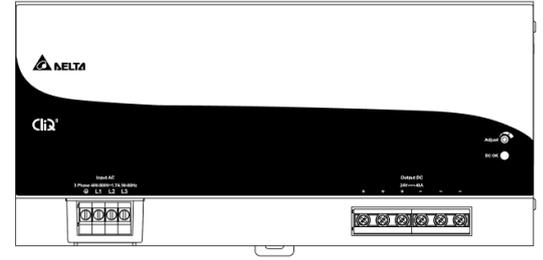
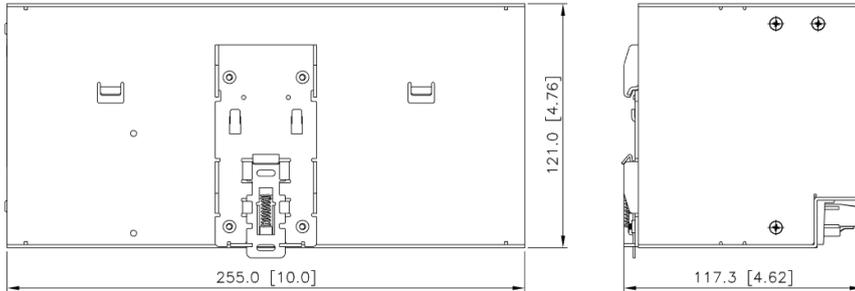

Engineering Data

Output Load De-rating VS Surrounding Air Temperature

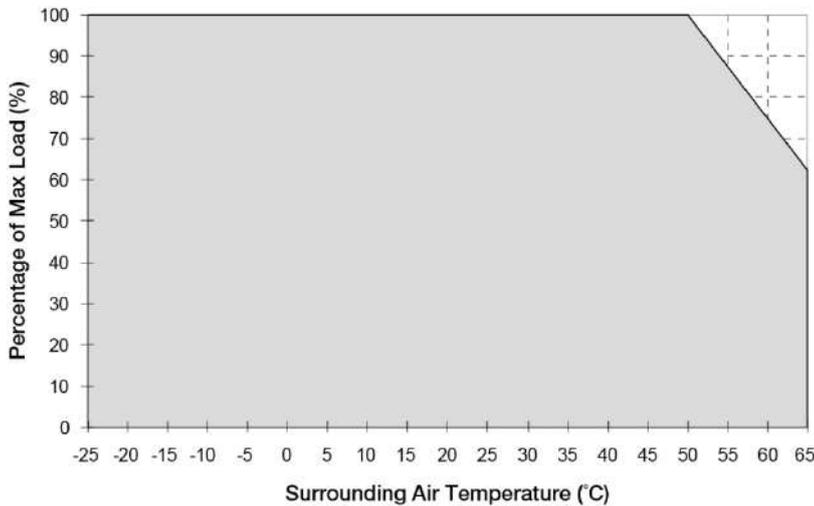

Fig. 1 De-rating for Vertical Mounting Orientation
> 50°C de-rate power by 2.5% / °C

Note

1. Power supply components may degrade, or be damaged, when the power supply is continuously used outside the shaded region, refer to the graph shown in Fig. 1.
2. If the output capacity is not reduced when the surrounding air temperature exceeds its specification as defined on Page 3 under "Environment", the device may run into Over Temperature Protection. When activated, the output voltage will go into bouncing mode and will recover when the surrounding air temperature is lowered or the load is reduced as far as necessary to keep the device in working condition.
3. In order for the device to function in the manner intended, it is also necessary to keep a safety distance as recommended in the safety instructions while the device is in operation.
4. Depending on the surrounding air temperature and output load delivered by the power supply, the device can be very hot!
5. If the device has to be mounted in any other orientation, please contact info@deltapsu.com for more details.

CliQ II DIN Rail Power Supply

24 V 960 W 3 Phase / DRP024V960W3BN

Output Load De-rating VS Input Voltage

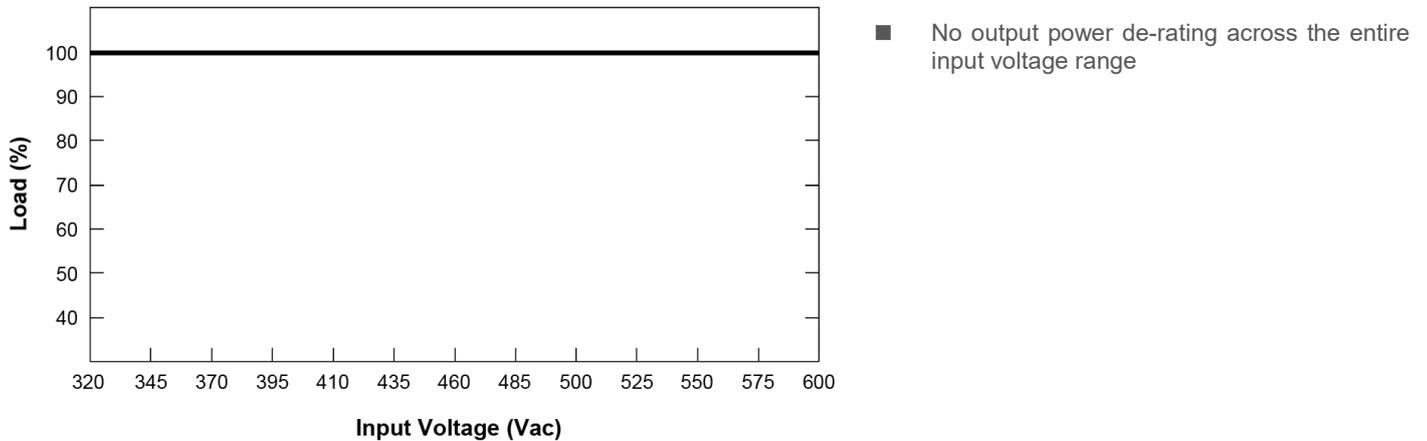

Assembly & Installation

The power supply unit (PSU) can be mounted on 35 mm DIN rails in accordance with EN 60715. For Vertical Mounting, the device should be installed with input terminal block at the bottom.

Each device is delivered ready to install.

Mounting

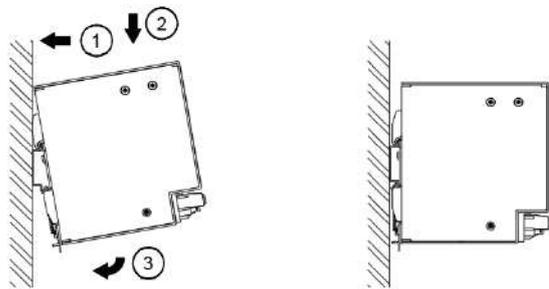

Fig. 2.1 Mounting

Snap on the DIN rail as shown in Fig. 2.1:

1. Tilt the unit upwards and insert it onto the DIN rail.
2. Push downwards until stopped.
3. Press against the bottom front side for locking.
4. Shake the unit slightly to ensure that it is secured.

Dismounting

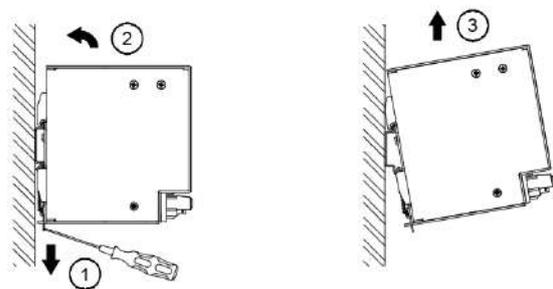

Fig. 2.2 Dismounting

To uninstall, pull or slide down the latch with screw driver as shown in Fig. 2.2. Then slide the power supply unit (PSU) in the opposite direction, release the latch and pull out the power supply unit (PSU) from the rail.

In accordance to EN 60950 / UL 60950 and EN 62368 / UL 62368, flexible cables require ferrules.

Use appropriate copper cables designed to sustain operating temperature of:

1. 60°C, 60°C / 75°C for USA
2. At least 75°C for ambient not exceeding 60°C, and 90°C for ambient exceeding 60°C for Canada.

CliQ II DIN Rail Power Supply

24 V 960 W 3 Phase / DRP024V960W3BN

Safety Instructions

■ Vertical Mounting

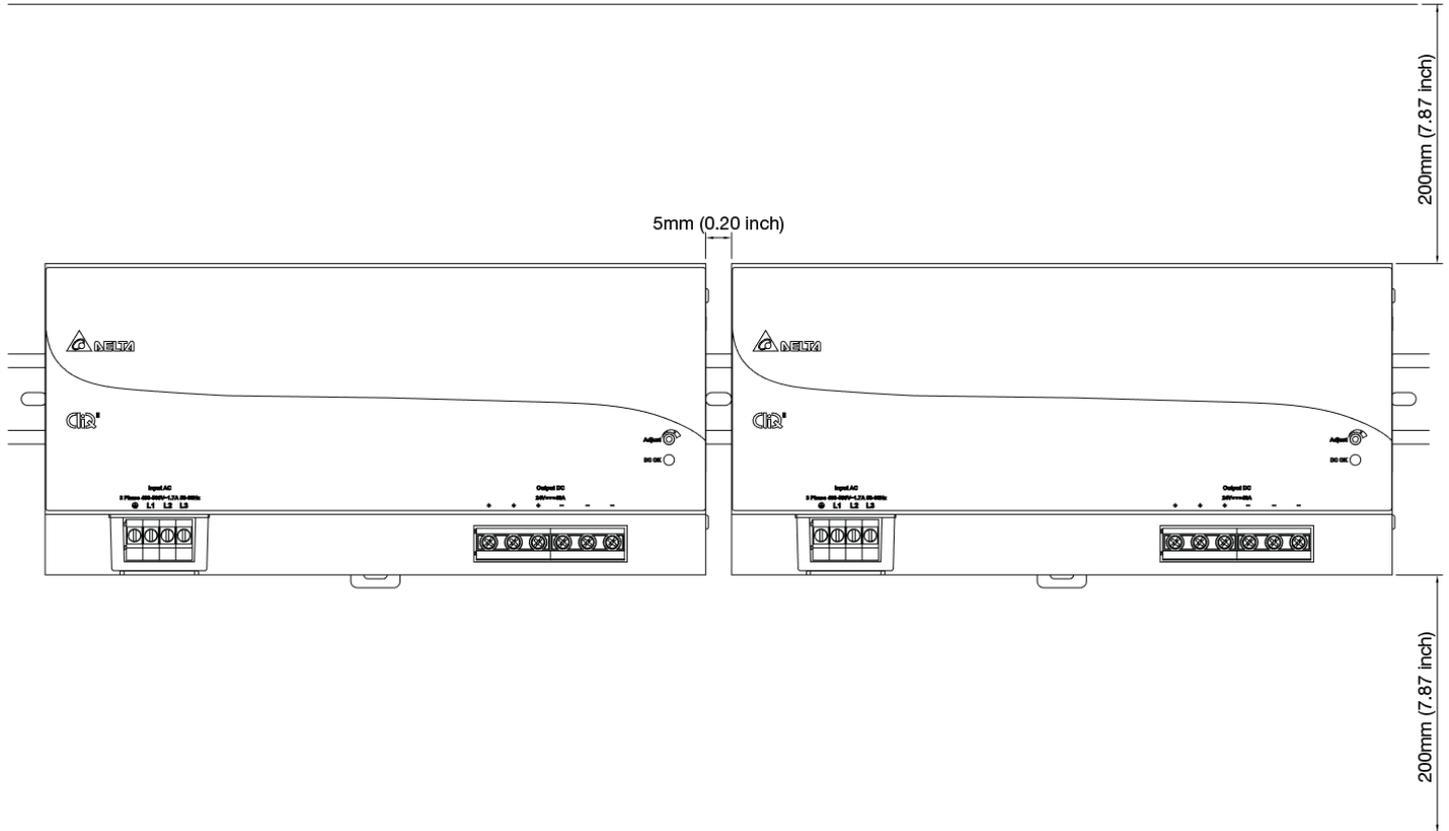

- ALWAYS switch mains of input power OFF before connecting and disconnecting the input voltage to the unit. If mains are not turned OFF, there is risk of explosion / severe damage.
- **To guarantee sufficient convection cooling, keep a distance of 200 mm (7.87 inch) above and below the device as well as a lateral distance of 5mm (0.20 inch) to other units.**
- Note that the enclosure of the device can become very hot depending on the surrounding air temperature and load of the power supply. Risk of burns!
- Only plug in and unplug connectors when power is turned off!
- DO NOT insert any objects into the unit.
- Hazardous voltages may be present for up to 5 minutes after the input mains voltage is disconnected. Do not touch the unit during this time.
- The power supplies are built in units and must be installed in a cabinet or room (condensation free environment and indoor location) that is relatively free of conductive contaminants.

CliQ II DIN Rail Power Supply

24 V 960 W 3 Phase / DRP024V960W3BN

Functions

- Graph illustrating the Start-up Time, Rise Time, and Hold-up Time

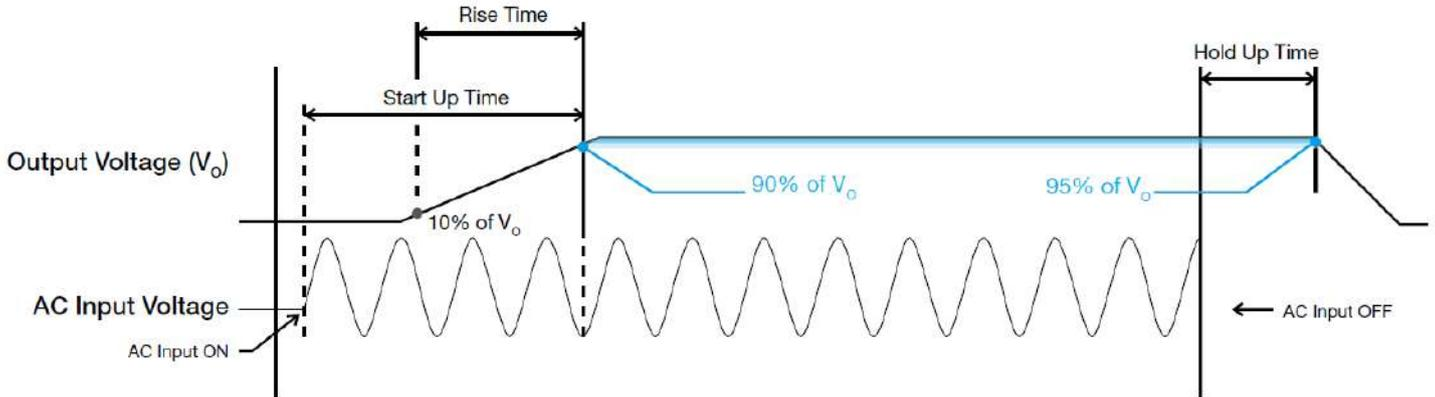

Start-up Time

The time required for the output voltage to reach 90% of its final steady state set value, after the input voltage is applied.

Rise Time

The time required for the output voltage to change from 10% to 90% of its final steady state set value.

Hold-up Time

Time between the collapse of the AC input voltage, and the output falling to 95% of its steady state set value.

Inrush Current

Inrush current is the peak, instantaneous, input current measured and, occurs when the input voltage is first applied. For AC input voltages, the maximum peak value of inrush current will occur during the first half cycle of the applied AC voltage. This peak value decreases exponentially during subsequent cycles of AC voltage.

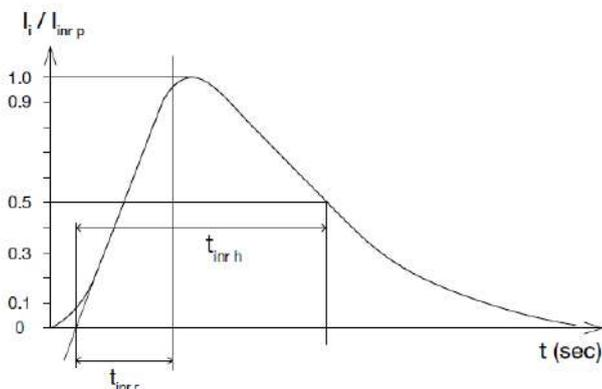

Dynamic Response

The power supply output voltage will remain within $\pm 5\%$ of its steady state value, when subjected to a dynamic load from 10% to 100% of its rated current.

- 50% duty cycle / 5 Hz to 1 KHz

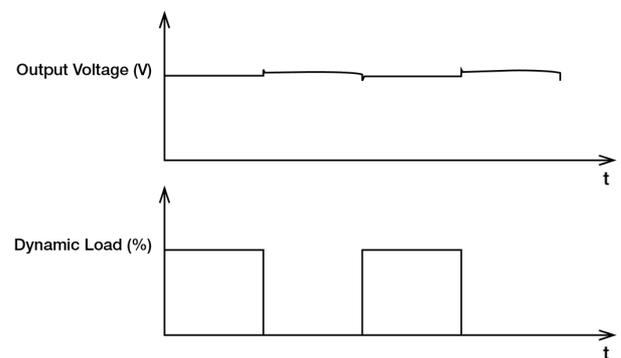

CliQ II DIN Rail Power Supply

24 V 960 W 3 Phase / DRP024V960W3BN

Power Boost

Power Boost is the reserve power available constantly that allows reliable startup to support sudden and short spike of loads with high inrush current typically during turn on to remove the need of more expensive higher rated power supply unit. After the output has reached its steady state set value, the power supply can support surge loads with a higher short-term power demand up to 150% of maximum rated load (I_o Max), for a maximum duration of 5 seconds. The Power Boost is also available to repeatedly basis with according to the condition of an average (R.M.S) output power shall not exceed continuous operating condition or refer to duty cycle calculation below.

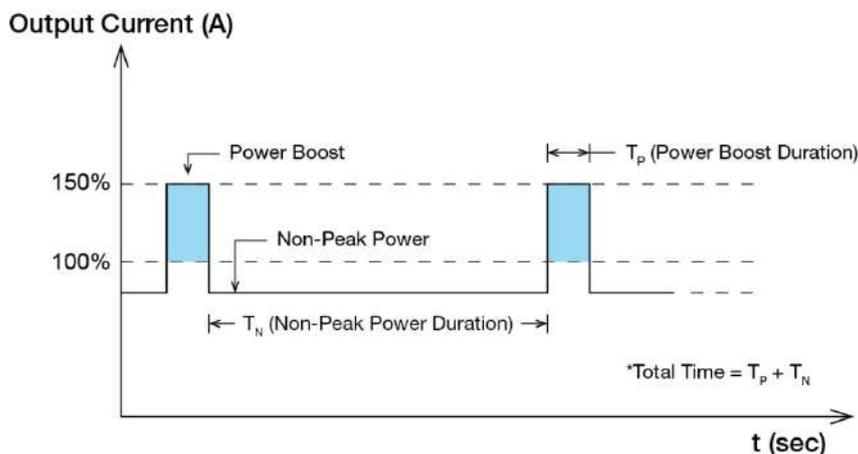

Fig. 3 Duty Cycle Calculation

$$Duty\ cycle\ (\%) = \frac{T_p}{Total\ Time}$$

$$Average\ Output\ Power\ (P_{Avg}) = \frac{(Power\ Boost \times T_p) + (Non-Peak\ Power \times T_N)}{Total\ Time}$$

OR

$$Non-Peak\ Power = \frac{(P_{Avg} \times Total\ Time) - (Power\ Boost \times T_p)}{T_N}$$

■ An example of Power Boost and Average Output Power

Power Boost	Peak Power (W _P)	Power Boost Duration (T _P)	Duty Cycle	Non-Peak Power (W _N)	Non-Peak Power Duration (T _N)	Total Time (T)
150%	1440	5 sec	10%	907 W	45 sec	50 sec
150%	1440	5 sec	35%	702 W	9.3 sec	14.3 sec
120%	1152	10 sec	20%	912 W	40 sec	50 sec
120%	1152	10 sec	35%	856 W	18.5 sec	28.5 sec

It is not recommended to prolong the duration of Power Boost to be longer than the specified duty cycle calculation, this may cause damage to the PSU.

External Input Protection Device

The unit is protected with internal fuse (not replaceable) at L1, L2 and L3 pins, which have been tested and approved on 20 A (UL) and 16 A (IEC) branch circuits without additional protection device. An external protection device is only required if the supplying branch has an ampacity greater than above. Thus, if an external protective device is necessary, or, utilized, a minimum value of 10 A B- or 6 A C-characteristic breaker should be used.

CliQ II DIN Rail Power Supply

24 V 960 W 3 Phase / DRP024V960W3BN

Overload & Overcurrent Protections (Auto-Recovery)

The power supply's Overload (OLP) and Overcurrent (OCP) Protections will be activated when output current (I_o) exceeds its specification as defined on Page 3 under "Protections". In such occurrence, the output voltage (V_o) will start to droop and once the power supply has reached its maximum power limit, the protection is activated and the power supply will go into "Hiccup mode" (Auto-Recovery). The power supply will recover once the fault condition of the OLP and OCP is removed and I_o is back within the specifications.

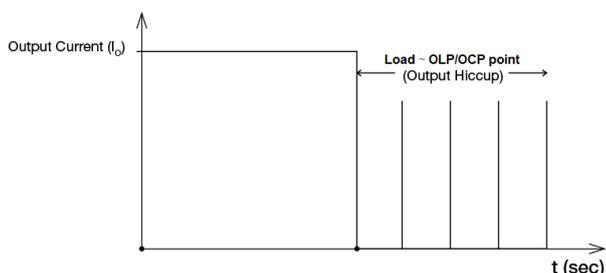

It is not recommended to prolong the duration of I_o when it is less than OLP/OCP point, but greater than 100%, since it may cause damage to the PSU.

Short Circuit Protection (Auto-Recovery)

The power supply's output OLP/OCP function also provides protection against short circuits. When a short circuit is applied, the output current will operate in "Hiccup mode", as shown in the illustration in the OLP/OCP section on this page. The power supply will return to normal operation after the short circuit is removed.

Overvoltage Protection (Auto-Recovery)

The power supply's overvoltage circuit will be activated when its internal feedback circuit fails. The output voltage shall not exceed its specifications defined on Page 3 under "Protections".

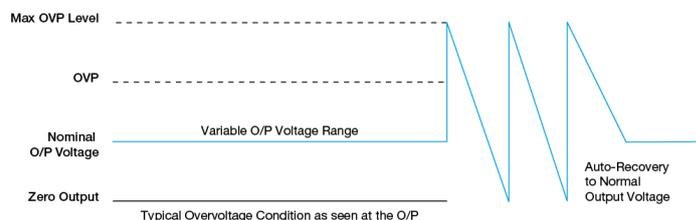

Over Temperature Protection (Auto-Recovery)

As described in load de-rating section, the power supply also has Over Temperature Protection (OTP). In the event of a higher operating temperature at 100% load, the power supply will run into OTP when the operating temperature is beyond what is recommended in the de-rating graph. When activated, the output voltage will go into bouncing mode until the temperature drops to its normal operating temperature as recommended in the de-rating graph.

CliQ II DIN Rail Power Supply

24 V 960 W 3 Phase / DRP024V960W3BN

Operating Mode

■ Redundant Operation

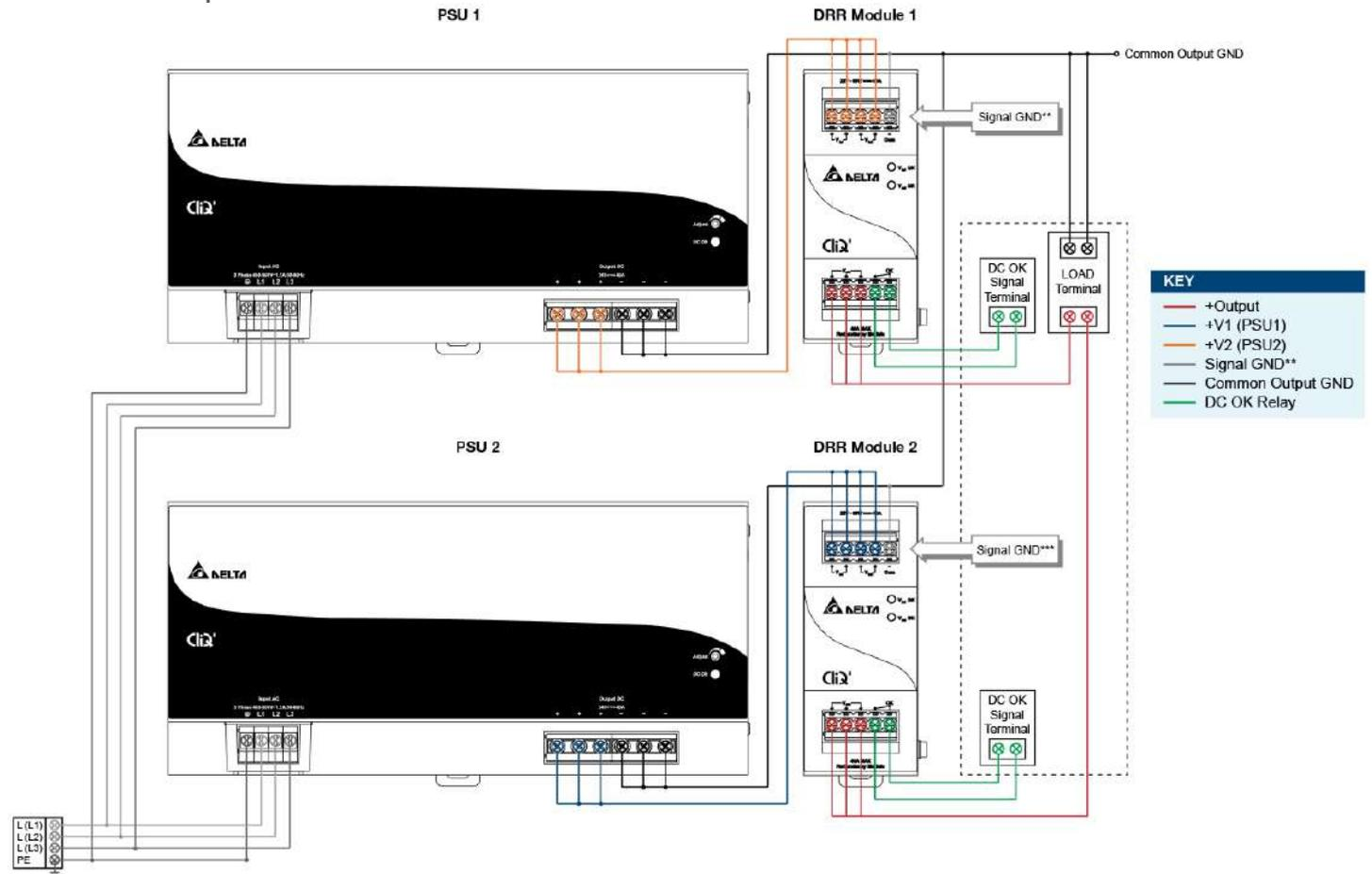

**The Signal GND in the DRR module is for the built-in LED and DC OK signals. The Output GND terminals from the two PSU's do not need to be connected to the Signal GND terminal.

Fig. 4 Redundant Operation Connection Diagram

In order to ensure proper redundancy operation for the power supply unit (PSU), ensure that the output voltage difference between the two units must be kept at 0.45~0.50 V for 24 V supplies. Follow simple steps given below to set them up for the redundant operation:

Step 1.

Measure output voltage of PSU 1 and PSU 2. If PSU 1 is the master unit, then V_o of PSU 1 must be higher than PSU 2. In order to set the output voltage, individually connect the power supply to 50% of rated load at any line voltage of 3 x 320-600 Vac (3-Phase) or 2 x 380-600 Vac (2-Phase), and set the PSU 1 and PSU 2 output voltage.

Step 2.

Connect the right DRR module, 40 A as per the system requirement to the power supply units. PSU 1 should be connected to DRR Module 1 at $V_{in 1}$ & $V_{in 2}$, and PSU 2 should be connected to DRR Module 2 at $V_{in 1}$ & $V_{in 2}$.

Step 3.

Connect the system load from V_{out} . Please note that output voltage V_{out} from DRR module will be = V_o (output voltage of power supply) - V_{drop}^* (in DRR module).

* V_{drop} Will vary from 0.60V to 0.90V (Typical 0.65V) depending on the load current and surrounding air temperature.

CliQ II DIN Rail Power Supply

24 V 960 W 3 Phase / DRP024V960W3BN

■ Parallel Operation

The power supply units (PSUs) can also be used for parallel operation in order to increase the output power. The difference in output voltage between the two units must be kept to within 25 mV of each other. This difference must be verified with the same output load connected independently to each unit.

Parameters such as EMI, inrush current, leakage current, PARD, start up time will be different from those on the datasheet, when two units are connected in parallel. The user will need to verify that any differences will still allow the two power supplies connected in parallel will work properly in their product/application.

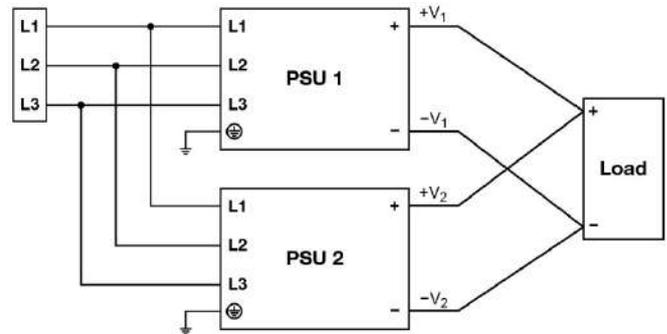

Fig. 5 Parallel Operation Connection Diagram

■ DC Input Operation

Step 1.
Use a battery or similar DC source.

Step 2.
Connect either connections of +pole and -pole to L1/L2/L3 as below.

- +pole to L1 and -pole to L2
- +pole to L1 and -pole to L3
- +pole to L2 and -pole to L1
- +pole to L2 and -pole to L3
- +pole to L3 and -pole to L1
- +pole to L3 and -pole to L2

Step 3.
Connect the PE terminal to an earth wire or to the machine ground.

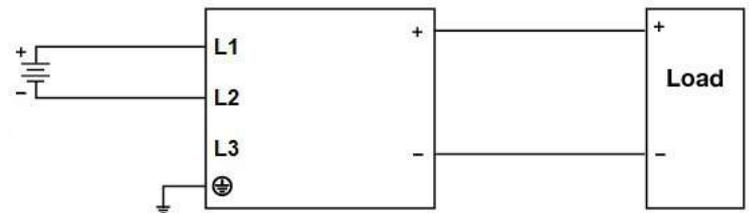

Fig. 6 DC Input Operation Connection Diagram

CliQ II DIN Rail Power Supply

24 V 960 W 3 Phase / DRP024V960W3BN

Others

Conformal Coating



The Protective Coating Technology

Delta Electronics Group has designed the perfect dipping technique which penetrates everywhere including under device, and prevents leakage. The conformal coating dipping can be applied to PCBs or circuit board. The coating preserves the performance of precision electronic primarily by preventing ionizable contaminants such as salt from reaching circuit nodes, where the material slumps around sharp edges. This can be a problem especially in highly conversing atmosphere.

PFC – Norm EN 61000-3-2

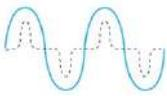

Line Current Harmonic content

Typically, the input current waveform is not sinusoidal due to the periodical peak charging of the input capacitor. In industrial environment, complying with EN 61000-3-2 is only necessary under special conditions. Complying to this standard can have some technical drawbacks, such as lower efficiency as well as some commercial aspects such as higher purchasing costs. Frequently, the user does not profit from fulfilling this standard, therefore, it is important to know whether it is mandatory to meet this standard for a specific application.

Attention

Delta provides all information in the datasheets on an “AS IS” basis and does not offer any kind of warranty through the information for using the product. In the event of any discrepancy between the information in the catalog and datasheets, the datasheets shall prevail (please refer to www.DeltaPSU.com for the latest datasheets information). Delta shall have no liability of indemnification for any claim or action arising from any error for the provided information in the datasheets. Customer shall take its responsibility for evaluation of using the product before placing an order with Delta.

Delta reserves the right to make changes to the information described in the datasheets without notice.

Manufacturer and Authorized Representatives Information

Manufacturer

Thailand

Delta Electronics (Thailand) PCL.
909 Pattana 1 Rd., Muang, Samutprakarn, 10280 Thailand

Taiwan

Delta Electronics, Inc.
3 Tungyuan Road, Chungli Industrial Zone, Taoyuan County
32063, Taiwan

Authorized Representatives

The Netherlands

Delta Greentech (Netherlands) B.V.
Zandsteen 15, 2132 MZ Hoofddorp, The Netherlands

United Kingdom

Delta Electronics Europe Limited
1 Redwood Court, Peel Park Campus,
East Kilbride, Glasgow, G74 5PF, United Kingdom

Mouser Electronics

Authorized Distributor

Click to View Pricing, Inventory, Delivery & Lifecycle Information:

[Delta Electronics:](#)

[DRP024V960W3BN](#)