

# LYTE II DIN Rail Power Supply

## DRL-240W series / DRL-□V240W1EN□



# LYTE II

### Highlights & Features

- Universal AC input voltage range
- Built-in constant current circuit for reactive loads
- High power density
- Operate from -30°C to +70°C with -40°C Cold Start
- Reduced no-load power consumption
- Compliance with DOE VI Energy Standard
- Compliance to SEMI F47 @ 200 Vac

### Safety Standards



CB Certified for worldwide use

**Model Number:** DRL-□V240W1EN□  
**Unit Weight:** 0.62 kg (1.37 lb)  
**Dimensions (H x W x D):** 123.6 x 40 x 116.8 mm  
 (4.87 x 1.57 x 4.60 inch)

### General Description

Delta's LYTE II DIN rail power supply series is designed for cost sensitive users who need to fulfill essential features needed for many general industrial applications, without compromising on quality and reliability. The convection-cooled LYTE II series will operate full power from -30°C to +50°C, then de-rating up to +70°C at 230 Vac. It can operate in constant current mode, making it suitable for inductive and capacitive loads. The product is certified according to safety standards IEC/EN/UL 62368-1. Electromagnetic radiated and conducted emissions are compliant to heavy industrial EN 61000-6-4 Class B Emission standard and EN 61000-6-2 Immunity standard. The product comply with environmental protection requirements as per RoHS Directive.

### Model Information

LYTE II DIN Rail Power Supply

Model Number	Input Voltage Range	Rated Output Voltage	Rated Output Current
DRL-12V240W1EN□	90-264 Vac	12 Vdc	20.0 A
DRL-15V240W1EN□		15 Vdc	16.0 A
DRL-24V240W1EN□		24 Vdc	10.0 A
DRL-48V240W1EN□		48 Vdc	5.0 A

### Model Numbering

DR	L -	□V	240W	1	E	N	□
DIN Rail	Product Type L – LYTE Family	Output Voltage 12 – 12 V 15 – 15 V 24 – 24 V 48 – 48 V	Output Power	Single Phase	LYTE II Series with Slim Design	N – No DC OK Relay Contact	Blank – No coating A – With coating

# LYTE II DIN Rail Power Supply

## DRL-240W series / DRL-□V240W1EN□

### Specifications

Model Number	DRL-12V240W1EN□	DRL-15V240W1EN□	DRL-24V240W1EN□	DRL-48V240W1EN□
--------------	-----------------	-----------------	-----------------	-----------------

### Input Ratings / Characteristics

Nominal Input Voltage	100-240 Vac			
Input Voltage Range	90-264 Vac			
Nominal Input Frequency	50-60 Hz			
Input Frequency Range	47-63 Hz			
Input Current	2.5 A typ. @ 115 Vac, 1.3 A typ. @ 230 Vac			
Efficiency at 100% Load	86.5% typ. @ 230 Vac	87.0% typ. @ 230 Vac	90.0% typ. @ 230 Vac	90.5% typ. @ 230 Vac
Average Efficiency (25%, 50%, 75%, 100%)	88.0% typ. @ 115 Vac	88.5% typ. @ 115 Vac	88.0% typ. @ 115 Vac	88.0% typ. @ 115 Vac
No Load Power Consumption	0.15 W max @ 115 Vac & 230 Vac	0.21 W max @ 115 Vac & 230 Vac	0.21 W max @ 115 Vac & 230 Vac	0.3 W max @ 115 Vac & 230 Vac
Max Inrush Current (Cold Start)	40 A typ. @ 230 Vac			
Power Factor at 100% Load	> 0.95 @ 115 Vac & 230 Vac			
Leakage Current	< 0.75 mA @ 240 Vac			

### Output Ratings / Characteristics\*<sup>2</sup>

Nominal Output Voltage	12 Vdc	15 Vdc	24 Vdc	48 Vdc
Factory Set Point Tolerance	12 Vdc ± 1%	15 Vdc ± 1%	24 Vdc ± 1%	48 Vdc ± 1%
Output Voltage Adjustment Range	10.8-13.2 Vdc	13.5-16.5 Vdc	21.6-26.4 Vdc	43.2-52.8 Vdc
Output Current	20.0 A	16.0A	10.0 A	5.0 A
Output Power	240 W max			
Line Regulation	± 0.5% @ 115 Vac & 230 Vac			
Load Regulation	± 1.0%	± 1.0%	± 0.5%	± 0.5%
PARD* <sup>3</sup> (20 MHz)	< 120 mVpp @ 0°C to +70°C < 360 mVpp @ -30°C to 0°C	< 120 mVpp @ 0°C to +70°C < 360 mVpp @ -30°C to 0°C	< 150 mVpp @ 0°C to +70°C < 450 mVpp @ -30°C to 0°C	< 200 mVpp @ 0°C to +70°C < 600 mVpp @ -30°C to 0°C
Rise Time	30 ms typ. @ 115 Vac & 230 Vac			
Start-up Time	500 ms typ. @ 115 Vac & 230 Vac			
Hold-up Time	20 ms typ. @ 115 Vac (100% load) 20 ms typ. @ 230 Vac (100% load)			
Dynamic Response (Overshoot & Undershoot O/P Voltage)	± 10% @ 115 Vac & 230 Vac input, 10-100% load (Slew Rate: 2.5 A/μs, 50% duty cycle @ 5 Hz & 10 kHz)			
Start-up with Capacitive Loads	8,000 μF Max	8,000 μF Max	8,000 μF Max	3,000 μF Max

\*<sup>2</sup> For power will be de-rating from 40°C to 70°C @ 115 Vac & 50°C to 70°C @ 230 Vac, and Vin < 100 Vac, see Engineering Data power de-rating information.

\*<sup>3</sup> PARD is measured with an AC coupling mode, 5 cm wires, and in parallel to end terminal with 0.1 μF ceramic capacitor & 47 μF electrolytic capacitor. PSU need to burn in around 5 minutes when AMB ≤ 0°C

# LYTE II DIN Rail Power Supply

## DRL-240W series / DRL-□V240W1EN□

Model Number	DRL-12V240W1EN□	DRL-15V240W1EN□	DRL-24V240W1EN□	DRL-48V240W1EN□
--------------	-----------------	-----------------	-----------------	-----------------

### Mechanical

Case Cover / Chassis	SGCC / Aluminum		
Dimensions (H x W x D)	123.6 x 40 x 116.8 mm (4.87 x 1.57 x 4.60 inch)		
Unit Weight	0.62 kg (1.37 lb)		
Indicator	Green LED (DC OK)		
Cooling System	Convection		
Terminal*4	Input	3 Pins (Rated 300 V / 30 A)	
	Output	4 Pins (Rated 300 V / 20 A)	
Wire	Input	AWG 18-12 (Current rating can refer to "AWG Wire Table")	
	Output	AWG 18-12 (Current rating can refer to "AWG Wire Table")	
Mounting Rail	Standard TS35 DIN Rail in accordance with EN 60715		
Noise (1 Meter from power supply)	Sound Pressure Level (SPL) < 25 dBA		

\*4 The torque at the terminal connector shall not exceed 4 Kgf.cm. (3.47 lbf.in).

### Environment

Surrounding Air Temperature	Operating	-30°C to +70°C (-40°C Cold Start)
	Storage	-40°C to +85°C
Power De-rating	Temperature	> 40°C de-rate power by 1.67 % / °C @ 115 Vac > 50°C de-rate power by 2.5 % / °C @ 230 Vac
	Input Voltage	< 100 Vac de-rate power by 1% / Vac
Operating Humidity	20 to 90% RH (Non-Condensing)	
Operating Altitude	0 to 5,000 Meters (16,400 ft.)	
Shock Test	Non-Operating	IEC 60068-2-27, Half Sine Wave: 50 G for duration of 11 ms; 3 times per direction, 9 times in total
	Operating	IEC 60068-2-27, Half Sine Wave: 10 G for duration of 11 ms; 1 time in X axis
Vibration	Non-Operating	IEC 60068-2-6, Random: 5 Hz to 500 Hz (2.09 G); 20 min per axis for all X, Y, Z direction
	Operating	IEC 60068-2-6, Sine Wave: 10 Hz to 500 Hz @ 19.6 m/s <sup>2</sup> (2 G peak); 10 min per cycle, 60 min for X direction
Over Voltage Category	II (Compliance to EN 62477-1 OVC III with 2000 meters altitude)	
Pollution Degree	2	

# LYTE II DIN Rail Power Supply

## DRL-240W series / DRL-□V240W1EN□

Model Number	DRL-12V240W1EN□	DRL-15V240W1EN□	DRL-24V240W1EN□	DRL-48V240W1EN□
--------------	-----------------	-----------------	-----------------	-----------------

### Protections

Overvoltage	< 17.4 V, SELV Output, Latch Mode	< 21.75 V, SELV Output, Latch Mode	< 33.6 V, SELV Output, Latch Mode	< 64.8 V, SELV Output, Latch Mode
Overload / Overcurrent	105 - 150% of rated load current, Auto-recovery Continuous current limit Mode*5 (Vo > 80%)			
Over Temperature	Latch Mode			
Short Circuit	Hiccup Mode, Non-Latching (Auto-Recovery when the fault is removed)			
Internal Fuse at L pin	T4 A / 250 V			
Protection Against Shock	Class I with PE*6 connection			

\*5 Constant current limit protection for inductive and capacitive load applications

\*6 PE: Primary Earth

### Reliability Data

MTBF	Telcordia SR-332	> 700,000 hrs I/P: 115 Vac & 230 Vac, O/P: 100% load, Ta: 25°C
Expected Cap Life Time	10 years (230 Vac, 50% load @ 40°C)	

### Safety Standards / Directives

Electrical Safety	CB scheme TUV Bauart UL/cUL CCC BSMI EAC KC	IEC 62368-1, IEC 61010-1 & -2-201*7 EN 62368-1, EN 61010-1 & -2-201*7 UL 62368-1, UL 61010-1 & -2-201*7 GB4943.1 CNS14336-1 TP TC 004/2011 K 60950-1 (24 V model only)
CE	In conformance with EMC Directive 2014/30/EU and Low Voltage Directive 2014/35/EU	
UKCA	In conformance with Electrical Equipment (Safety) Regulations 2016 and Electromagnetic Compatibility Regulations 2016	
Galvanic Isolation	Input to Output	3.0 KVac
	Input to Ground	2.0 KVac
	Output to Ground	1.0 KVac

\*7 Only 12 V, 24 V, and 48 V models are certified to IEC/EN/UL 61010-1 & 2-201

# LYTE II DIN Rail Power Supply

## DRL-240W series / DRL-□V240W1EN□

Model Number	DRL-12V240W1EN□	DRL-15V240W1EN□	DRL-24V240W1EN□	DRL-48V240W1EN□
--------------	-----------------	-----------------	-----------------	-----------------

### EMC

Emissions (CE & RE)	CISPR 32, EN/BS EN 55032, EN/BS EN 61000-6-4, AS/NZS CISPR32, EN/BS EN 61204-3, KN 32 (24 V model only) Compliance to FCC Title 47, EN/BS EN 61000-6-3: Class B		
Component Power Supply for General Use	EN/BS EN 61204-3		
Immunity	EN/BS EN 55035, KN 35 (24 V model only), EN/BS EN 61000-6-2 Compliance to EN/BS EN 61000-6-1		
Electrostatic Discharge	IEC 61000-4-2	Level 4 Criteria A <sup>1)</sup> Air Discharge: 15 kV Contact Discharge: 8 kV	
Radiated Field	IEC 61000-4-3	Criteria A <sup>1)</sup> 80 MHz – 1 GHz, 10 V/M, 80% Modulation (1 kHz) 1.4 GHz – 2 GHz, 3 V/M, 80% Modulation (1 kHz) 2 GHz – 2.7 GHz, 1 V/M, 80% Modulation (1 kHz)	
Electrical Fast Transient / Burst	IEC 61000-4-4	Level 3 Criteria A <sup>1)</sup> 2 kV	
Surge	IEC 61000-4-5	Level 4 Criteria A <sup>1)</sup> Common Mode <sup>4)</sup> : 4 kV Differential Mode <sup>5)</sup> : 2 kV	
Conducted	IEC 61000-4-6	Level 3 Criteria A <sup>1)</sup> 150 kHz – 80 MHz, 10 Vrms	
Power Frequency Magnetic Fields	IEC 61000-4-8	Level 4 Criteria A <sup>1)</sup> 30 A/m	
Voltage Dips and Interruptions	IEC 61000-4-11	0% residual; 1 cycle, Criteria B <sup>2)</sup> 40% residual; 10 cycle, Criteria C <sup>3)</sup> 70% residual; 25 cycle, Criteria C <sup>3)</sup>	
Harmonic Current Emission	IEC/EN/BS EN 61000-3-2, Class A		
Voltage Fluctuation and Flicker	IEC/EN/BS EN 61000-3-3		
Voltage Sag Immunity SEMI F47 – 0706	80% of 200 Vac 70% of 200 Vac 50% of 200 Vac	160 Vac, 1000 ms 140 Vac, 500 ms 100 Vac, 200 ms	Criteria A <sup>1)</sup> Criteria A <sup>1)</sup> Criteria A <sup>1)</sup>

1) Criteria A: Normal performance within the specification limits

2) Criteria B: Temporary degradation or loss of function which is self-recoverable

3) Criteria C: Output out of regulation, shuts down during test (Need to recycle AC power cord to normal operation after test)

4) Asymmetrical: Common mode (Line to earth)

5) Symmetrical: Differential mode (Line to line)

# LYTE II DIN Rail Power Supply

## DRL-240W series / DRL-□V240W1EN□

### Block Diagram

DRL-□V240W1EN□

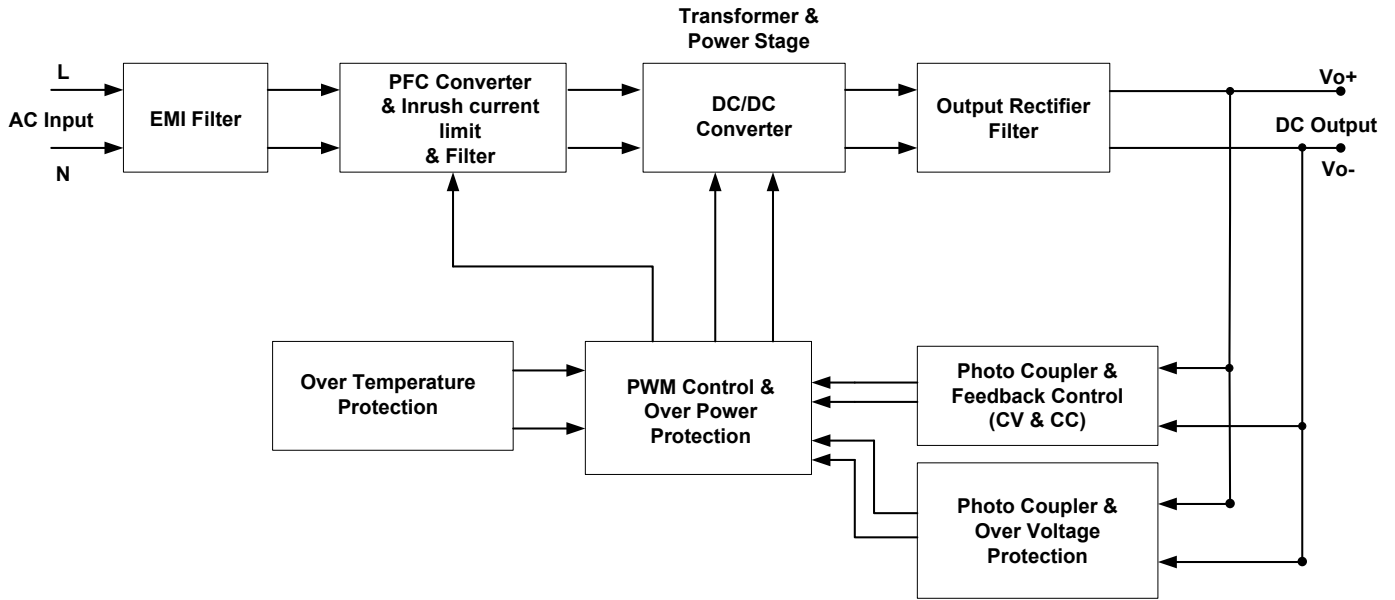

### Device Description

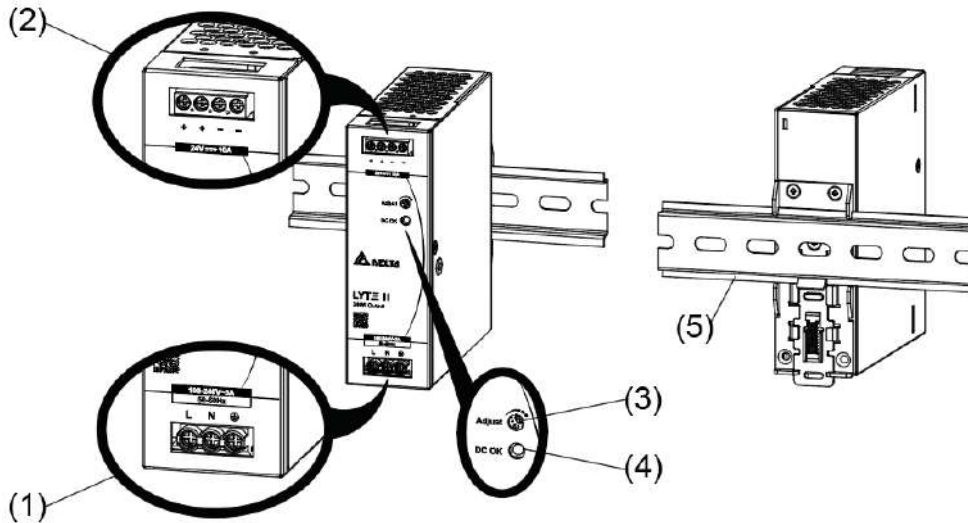

- 1) Input terminal block connector
- 2) Output terminal block connector
- 3) DC voltage adjustment potentiometer
- 4) DC OK LED (Green)
- 5) Universal mounting rail system

# LYTE II DIN Rail Power Supply

## DRL-240W series / DRL-□V240W1EN□

### Dimensions

H x W x D: 123.6 x 40 x 116.8 mm (4.87 x 1.57 x 4.60 inch)

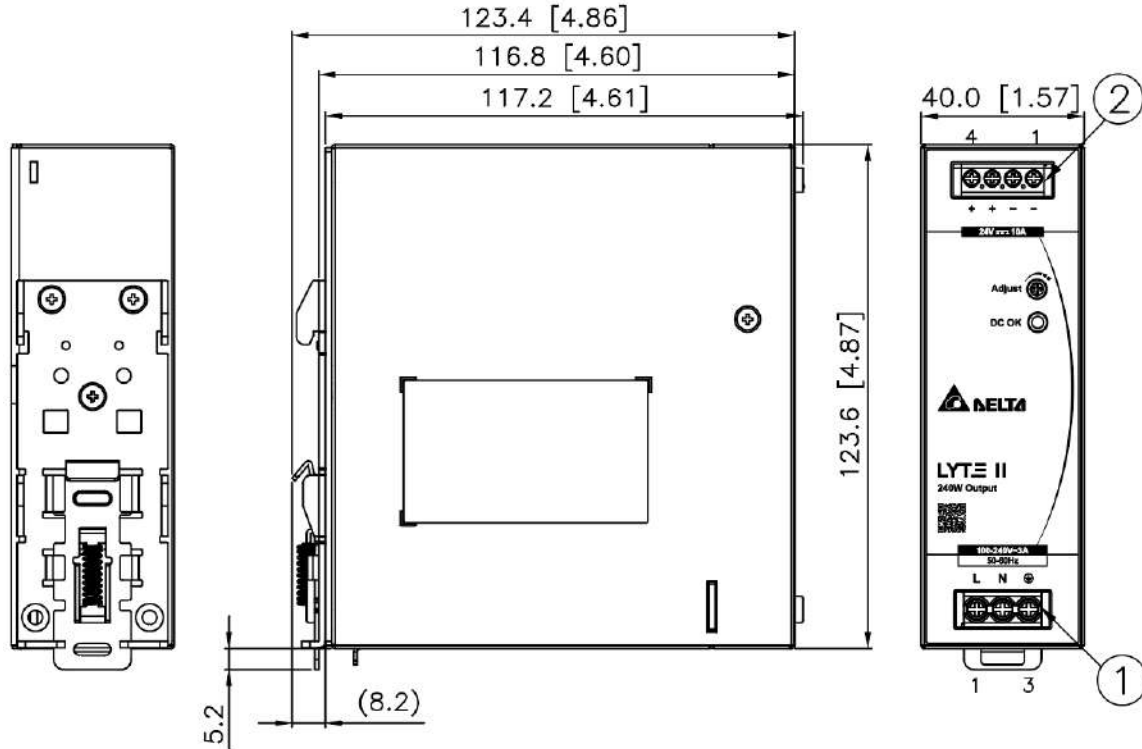

\*Unless otherwise specified tolerance of dimension are  $\pm 0.5$  mm

Item	Device Description
1	Input terminal block connector Pin 1: L Pin 2: N Pin 3: PE
2	Output terminal block connector Pin 1 to 2: V(-) Pin 3 to 4: V(+)

### AWG Wire Table

Current Rating for PVC Wire	
6 AWG	52.5 A
8 AWG	37.5 A
10 AWG	29.0 A
12 AWG	22.5 A
14 AWG	16.5 A
16 AWG	12.0 A
18 AWG	9.0 A
20 AWG	6.5 A
22 AWG	5.0 A
24 AWG	3.5 A
26 AWG	2.5 A
28 AWG	2.0 A
30 AWG	1.5 A

# LYTE II DIN Rail Power Supply

## DRL-240W series / DRL-□V240W1EN□

### Engineering Data

#### Output Load De-rating VS Surrounding Air Temperature

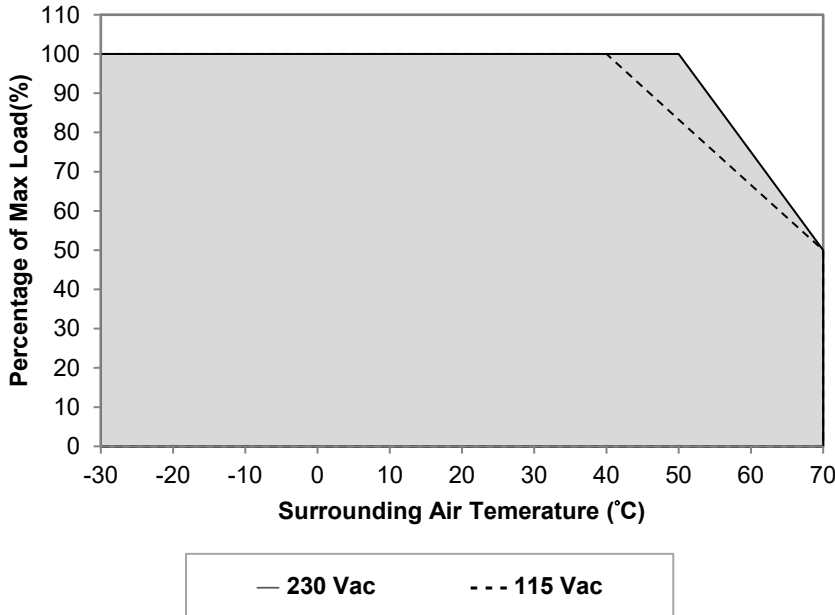
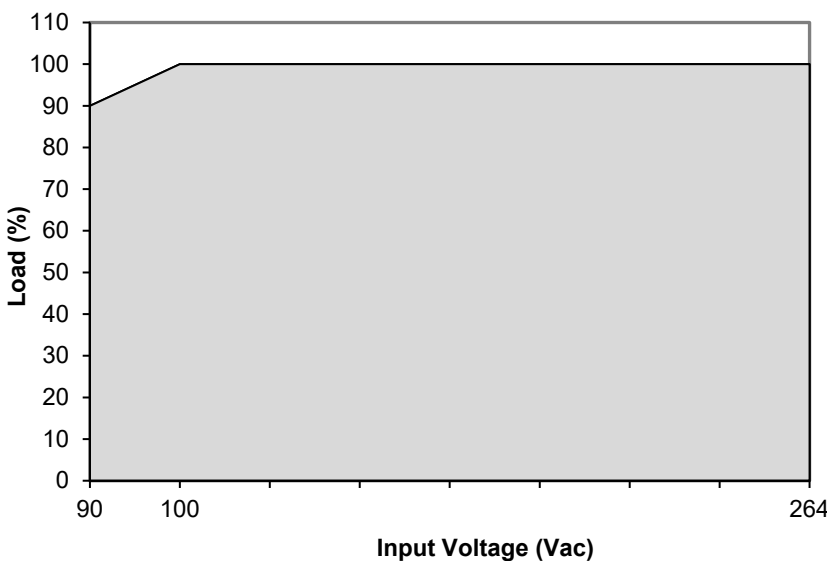

**Fig. 1 De-rating for Vertical Mounting Orientation**  
 > 40°C de-rate power by 1.67 % / °C @ 115 Vac  
 > 50°C de-rate power by 2.5 % / °C @ 230 Vac

#### Note

1. Power supply components may degrade, or be damaged, when the power supply is continuously used outside the shaded region, refer to the graph shown in Fig. 1.
2. The PSU will be bouncing and start up time will not exceed 5s when ambient temperature at -30 °C
3. If the output capacity is not reduced when the surrounding air temperature > 50°C, the device will run into Over Temperature Protection. When activated, power supply will latch off, until the surrounding air temperature is lowered or the load is reduced as far as necessary to keep the device in working condition, and require removal/re-application of input AC voltage in order to restart.
4. In order for the device to function in the manner intended, it is also necessary to keep a safety distance as recommended in the safety instructions while the device is in operation.
5. Depending on the surrounding air temperature and output load delivered by the power supply, the device can be very hot!
6. Need to consider power de-rating if Surrounding Air Temperature is < 40°C at 115 Vac and < 50°C at 230 Vac.
7. If the device has to be mounted in any other orientation, please leave a message via the [Contact Us](#) form.

#### Output Load De-rating VS Input Voltage



- No output power de-rating for the input voltage from 100 Vac to 264 Vac

**Fig. 2 De-rating for AC Input Voltage**  
 < 100 Vac de-rate power by 1 % / Vac



# LYTE II DIN Rail Power Supply

## DRL-240W series / DRL-□V240W1EN□

### Assembly & Installation

The power supply unit (PSU) can be mounted on 35 mm DIN rails in accordance with EN 60715. The device should be installed with input terminal block at the bottom.

Each device is delivered ready to install.

#### Mounting

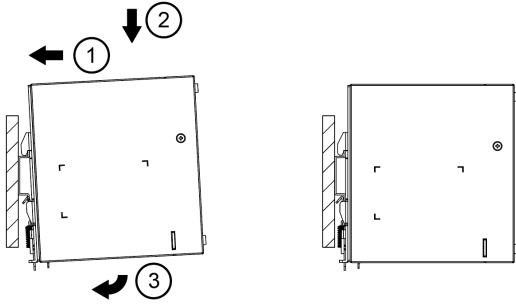

Fig. 3.1 Mounting

Snap on the DIN rail as shown in Fig. 3.1:

1. Tilt the unit upwards and insert it onto the DIN rail.
2. Push downwards until stopped.
3. Press against the bottom front side for locking.
4. Shake the unit slightly to ensure that it is secured

#### Dismounting

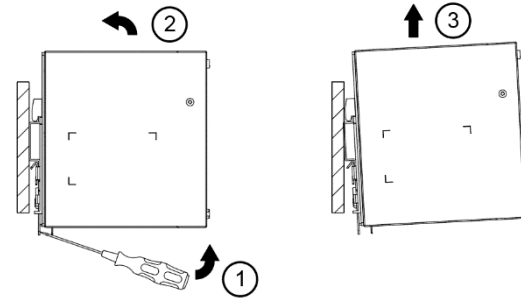
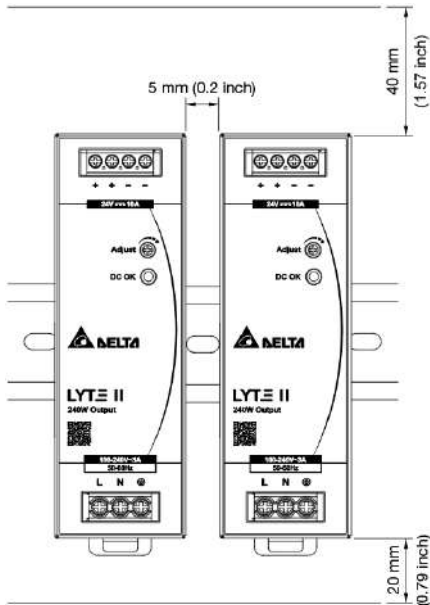

Fig. 3.2 Dismounting

To uninstall, Delta provides an easy way to pull or slide down the latch with screw driver as shown in Fig. 3.2. Then slide the power supply unit (PSU) in the opposite direction, release the latch and pull out the power supply unit (PSU) from the rail.

### Safety Instructions

#### Vertical Mounting



- ALWAYS switch mains of input power OFF before connecting and disconnecting the input voltage to the unit. If mains are not turned OFF, there is risk of explosion / severe damage.
- **To guarantee sufficient convection cooling, keep a distance of 40 mm (1.57 inch) above and 20 mm (0.79 inch) below the device as well as a lateral distance of 5 mm (0.2 inch) to other units and if load less than 50%, lateral distance can be 0 mm. In case the adjacent device is a heat source, the lateral distance will be 15 mm (0.6 inch).**
- Note that the enclosure of the device can become very hot depending on the surrounding air temperature and load of the power supply. Risk of burns!
- The main power must be turned off before connecting or disconnecting wires to the terminals.
- DO NOT insert any objects into the unit.
- Hazardous voltages may be present for up to 5 minutes after the input mains voltage is disconnected. Do not touch the unit during this time.
- The power supplies are built in units and must be installed in a cabinet or room (condensation free environment and indoor location) that is relatively free of conductive contaminants.

# LYTE II DIN Rail Power Supply

## DRL-240W series / DRL-□V240W1EN□

### Functions

- Graph illustrating the Start-up Time, Rise Time, and Hold-up Time

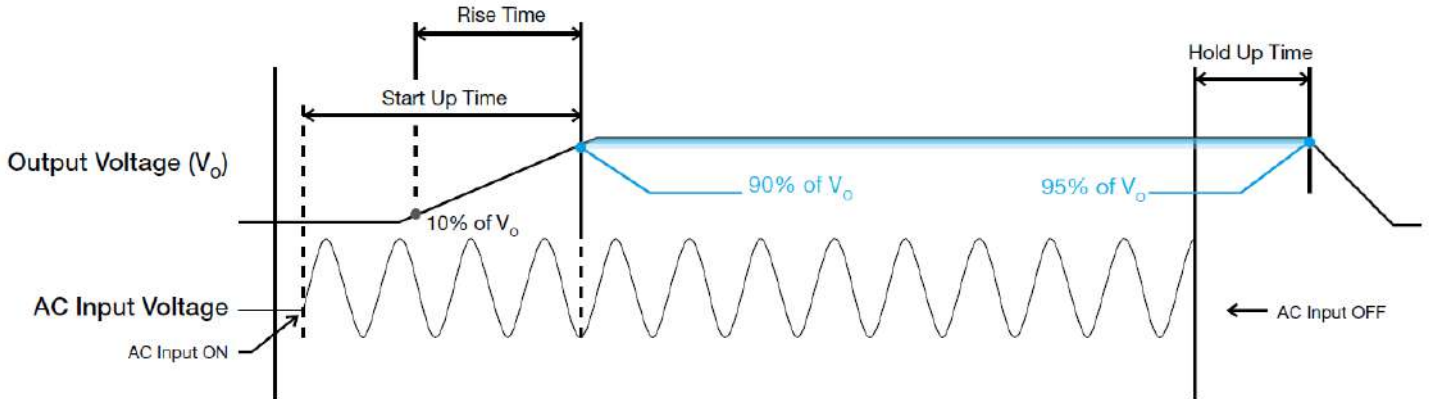

### Start-up Time

The time required for the output voltage to reach 90% of its final steady state set value, after the input voltage is applied.

### Rise Time

The time required for the output voltage to change from 10% to 90% of its final steady state set value.

### Hold-up Time

Time between the collapse of the AC input voltage, and the output falling to 95% of its steady state set value.

### Inrush Current

Inrush current is the peak, instantaneous, input current measured and, occurs when the input voltage is first applied. For AC input voltages, the maximum peak value of inrush current will occur during the first half cycle of the applied AC voltage. This peak value decreases exponentially during subsequent cycles of AC voltage.

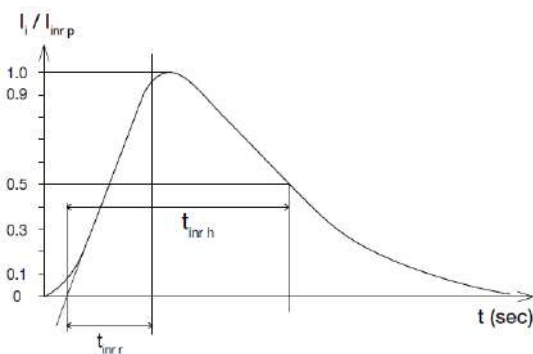

### Dynamic Response

The power supply output voltage will remain within  $\pm 10\%$  of its steady state value, when subjected to a dynamic load from 10% to 100% of its rated current.

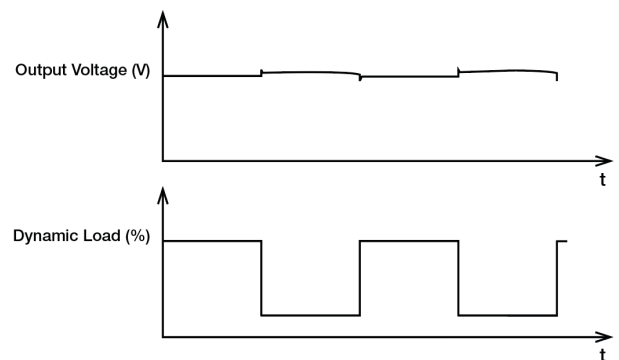

# LYTE II DIN Rail Power Supply

## DRL-240W series / DRL-□V240W1EN□

### Overload & Overcurrent Protections (Continuous Current)

The power supply offers constant current limit protection for inductive and capacitive load applications when output current range is 105~150% of  $I_o$  (Max load) and output voltage is more than 80%. Upon such an occurrence, the  $V_o$  (output voltage) will start to droop. Once the power supply has reached its maximum power limit, the protection will be activated; and, the power supply will operate in continuous current. The power supply will recover once the cause of OLP or OCP is removed, and  $I_o$  (output current) is back within the specified range.

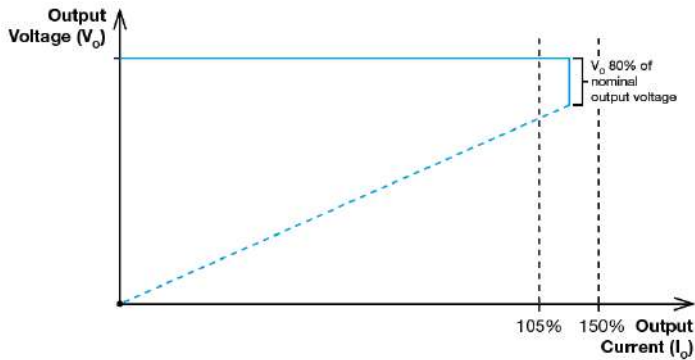

### Short Circuit Protection (Auto-Recovery)

The power supply's output Short Circuit Protection function also provides protection against short circuits. When a short circuit is applied, the output current will operate in "Hiccup mode". The power supply will return to normal operation after the short circuit is removed.

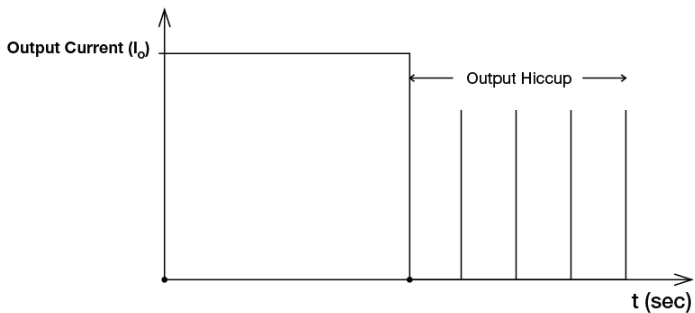

### Overvoltage Protection (Latch Mode)

The power supply's overvoltage circuit will be activated when its internal feedback circuit fails. The output voltage shall not exceed its specifications as described in "Protections" section. Power supply will latch off, and require removal/re-application of input AC voltage in order to restart.

The power supply should be latch.

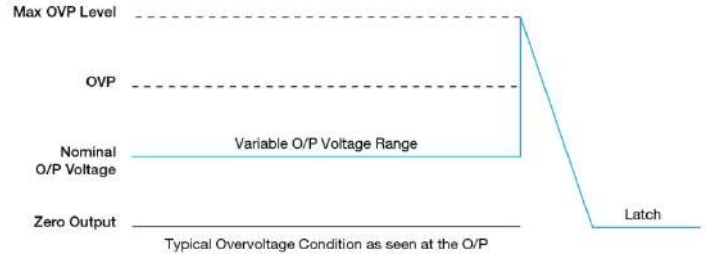

### Over Temperature Protection (Latch Mode)

As described in load de-rating section, the power supply also has Over Temperature Protection (OTP). In the event of a higher operating temperature at 100% load; or, when the operating temperature is beyond what is recommended in the de-rating graph, the OTP circuit will be activated. When activated, power supply will latch off, until the surrounding air temperature drops to its normal operating temperature or the load is reduced as recommended in the de-rating graph. Removal/re-application of input AC voltage will then be required in order to restart.

# LYTE II DIN Rail Power Supply

## DRL-240W series / DRL-□V240W1EN□

### Others

#### Attention

Delta provides all information in the datasheets on an "AS IS" basis and does not offer any kind of warranty through the information for using the product. In the event of any discrepancy between the information in the catalog and datasheets, the datasheets shall prevail (please refer to [www.DeltaPSU.com](http://www.DeltaPSU.com) for the latest datasheets information). Delta shall have no liability of indemnification for any claim or action arising from any error for the provided information in the datasheets. Customer shall take its responsibility for evaluation of using the product before placing an order with Delta.

Delta reserves the right to make changes to the information described in the datasheets without notice.

### Manufacturer and Authorized Representatives Information

#### Manufacturer

##### Thailand

Delta Electronics (Thailand) PCL.  
909 Pattana 1 Rd., Muang, Samutprakarn, 10280 Thailand

##### Taiwan

Delta Electronics, Inc.  
3 Tungyuan Road, Chungli Industrial Zone, Taoyuan County  
32063, Taiwan

#### Authorized Representatives

##### The Netherlands

Delta Greentech (Netherlands) B.V.  
Zandsteen 15, 2132 MZ Hoofddorp, The Netherlands

##### United Kingdom

Delta Electronics Europe Limited  
1 Redwood Court, Peel Park Campus,  
East Kilbride, Glasgow, G74 5PF, United Kingdom

# Mouser Electronics

Authorized Distributor

Click to View Pricing, Inventory, Delivery & Lifecycle Information:

[Delta Electronics:](#)

[DRL-12V240W1EN](#)